

# thebeamray *RFX70*

reflective optical beam smoke detector

## user guide



Issue 0180-01

20.05.20 rev 1

# thebeamray RFX70

## Reflective optical beam smoke detector **user guide**

---

### **1** Distance and position guidelines

These guidelines are recommendations only and it is important that you refer to your appropriate governing standards at all times.

When positioning your beamray RFX70 there are important factors that you should consider, mainly what distance you are covering and the optimal position in the building.

### What distance?

The standard beamray is suitable for distances of **7m to 70m** to the reflector. If you require **70m to 140m** you will need to use the **mid range reflector extension kit**. For ranges of **140m to 160m** you will require the **long range reflector extension kit**.

**NOTE.** for distances **under 20m** use the short range mask supplied on the single reflector.



### **7 to 70 metres** - the standard beamray

The standard beamray comes boxed with the head unit, low level controller, one reflector, short range mask, 3mm allen key and quick start installation guide, this should be used for distances over 7m and up to 70m.

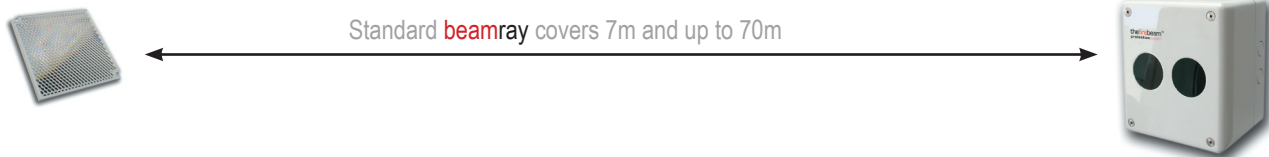

### **70 to 140 metres** - the standard beamray + mid range 70 to 140m kit

For distances of 70 to 140 metres you will need to use the standard beamray and a **mid range extension kit** (the mid range kit comes with a backing plate and 3 extra reflectors, you will need to add the reflector from the standard kit to the mid range kit with the screws provided).

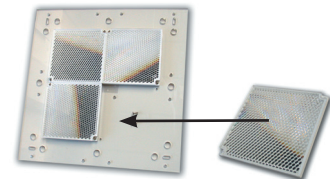

### **140 to 160 metres** - the standard beamray + long range 140 to 160m kit

For distances of 140 to 160 metres you will need to use the standard beamray and a **long range extension kit** (the long range kit comes with a backing plate and 8 extra reflectors, you will need to add the reflector from the standard kit to the long range kit with the screws provided).

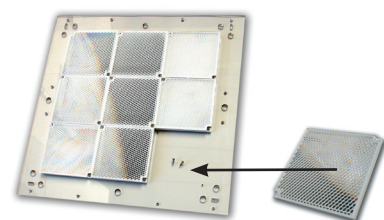

# What position?

A roof is considered flat unless the height of the apex is greater than 0.6m. If the roof is flat the **beamray** system can be placed anywhere under the roof between 0.3m and 0.6m below the roof, up to a maximum height of 40m from the floor. the **beamray** has a detection area of 7.5m either side of the beam. If the roof is considered to have an apex, place the **beamray** system 0.3m to 0.6m down from the top of the apex, up to a maximum height of 40m from the floor. The maximum protected area either side of the beam can be extended by 1% for every degree of roof pitch, see the example below: (please check with your local regulations)

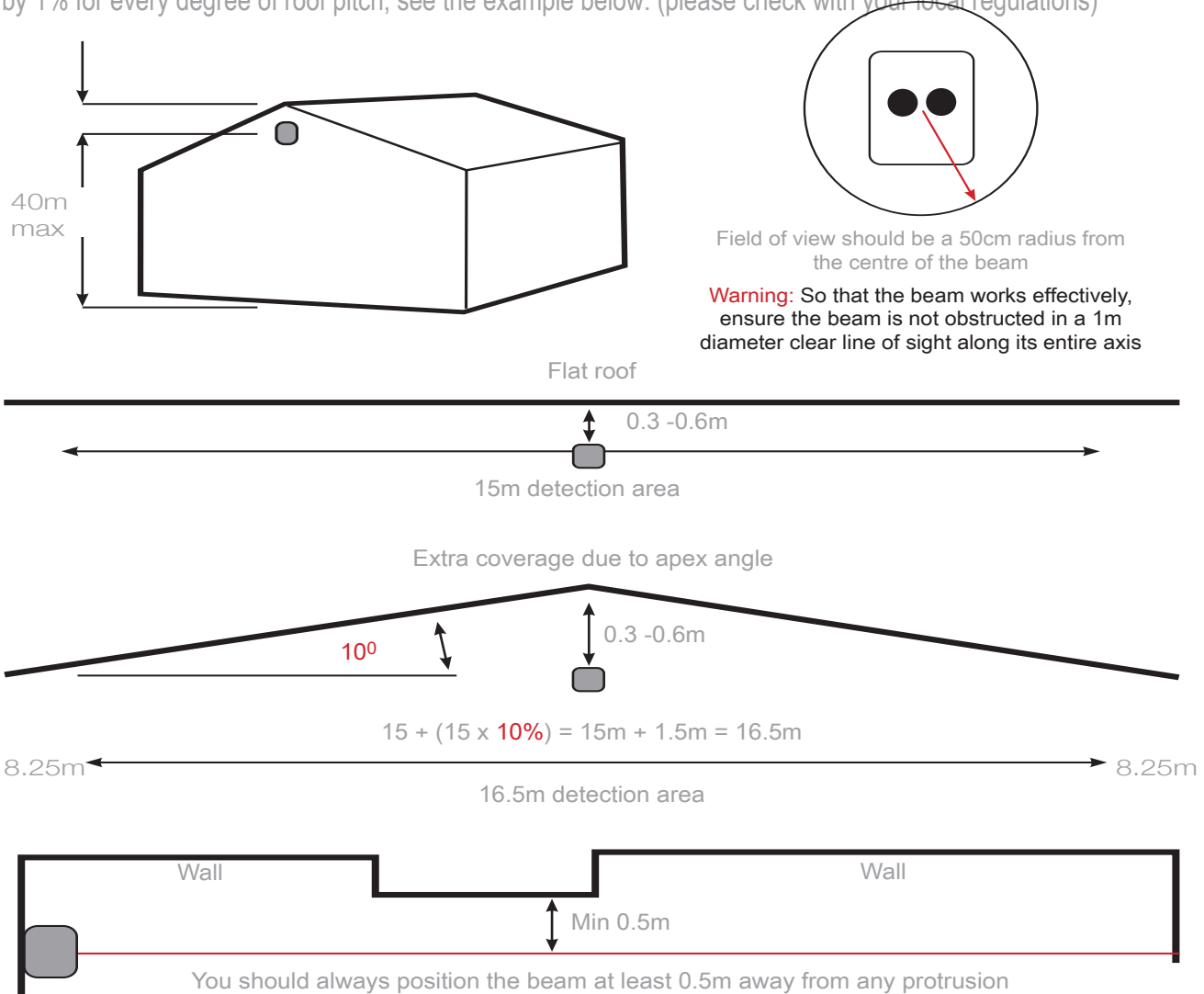

**Note.** Careful design consideration should be made when positioning beams and reflectors in environments that can be susceptible to condensation i.e. warehouses near to water that have areas open to the outside environment or that are exposed to quick extreme changes in temperature. To assist with this problem that can affect all beam detectors we produce an **anti-fog kit** comprising of a specially coated reflector and lens cover. Individual reflectors are also available. The standard **beamray** and range kits can be supplied as anti-fog sets as a special order.

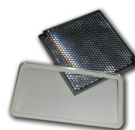

## 2 Installing, commissioning and testing

### step 1 mounting the head

Screw the head backing plate to the wall - always try to use as sturdy a location as possible, such as brick or major structural steels (avoid mounting to outer metal cladding etc). Avoid mounting the head where direct sunlight can shine directly into the 'eyes' of the beam (care should be taken when mounting in glass atriums). Ambient sunlight will not affect the beam.

Also available - unistrut adapter plate

Use this accessory for easy mounting to unistrut fabrication. Holes are pre-drilled to the correct pitch of the head and conveniently positioned for use with unistrut.

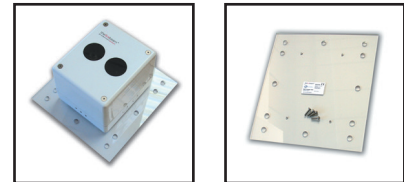

2 knock-outs are provided on both sides. **Take care when using drills not to damage the circuit board. Only punch out with head open and disconnected from power**

Wire to low level controller using bottom colour coded terminals.

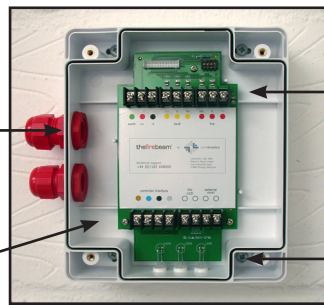

Wire into system as required (see generic wiring diagram on the following page). **Ensure that all wiring is below the level of the front edge of the box.**

Screw in through holes provided outside of the rubber seal.

Connect the head to the base plate by first plugging in the connector.

**Do not** force in, white wires should be uppermost. **Should you forget to connect this the controller screen will read ERROR.**

**To avoid damaging the detector head never dangle the front cover assembly from the ribbon cable.**



**IMPORTANT** ensure the connector is this way up.

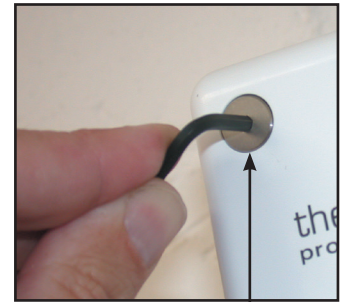

Screw the head screws down with the 3mm allen key provided.

**Your wiring should be flush and not flattened by tightening down screws.**

### step 2 mounting the controller

Important mount the controller at eye level and ensure easy access.



Screw in through holes provided outside of the rubber seal.

Wire to head using colour coded terminals.

If this connection is not made **ERROR** will appear on the controller, this connection can be checked by reading the resistance across the black and grey terminals, they will read 110 ohm if OK or 220 ohm if not connected properly.

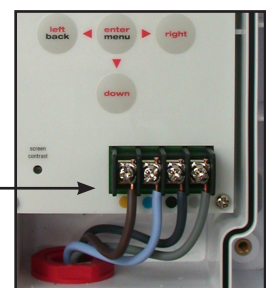

# Generic wiring configurations

thebeamray is a conventional device, below are suggested wiring configurations for single and multi heads on a zone. thebeamray can easily be made addressable with the use of a manufacturers interface and in some cases can also be powered from the loop. Most wiring diagrams can be found on our website in more detail and in PDF format, go to [www.contextplus.co.uk](http://www.contextplus.co.uk)

- Brown + supply (normal 12 - 30Vdc)
- Blue - supply (return)
- Black zone +
- Grey zone -
- Green earth (screen)

Supply voltage 12Vdc to 30Vdc normal  
 Quiescent current 3.5mA  
 Alarm current 3.5mA  
 Aligning current normal 3.5mA fast 17mA  
 Fault/Alarm relay contact rating 2A @ 30Vdc

## FIRE and EOL components as supplied by the panel manufacturer

### Single head on zone

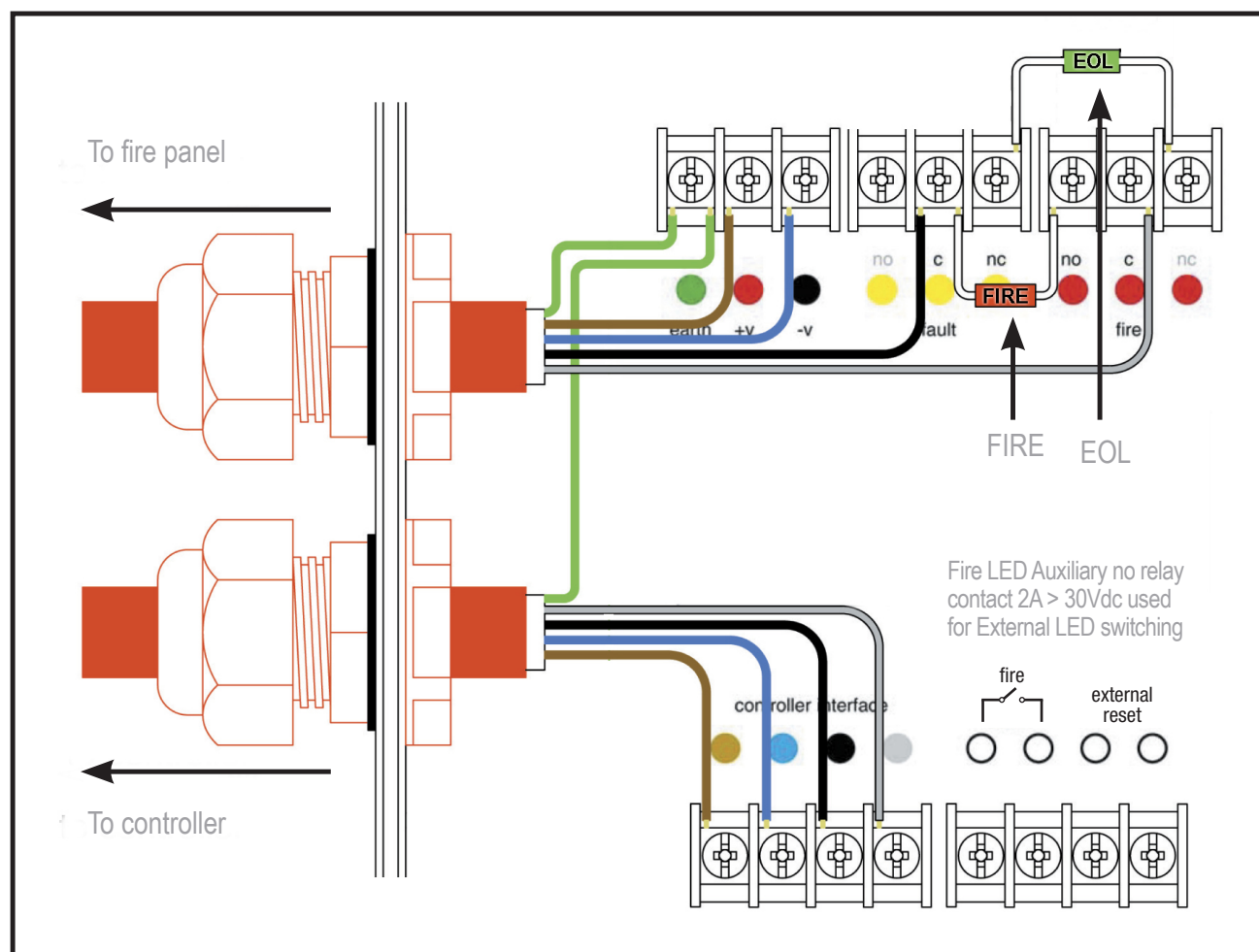

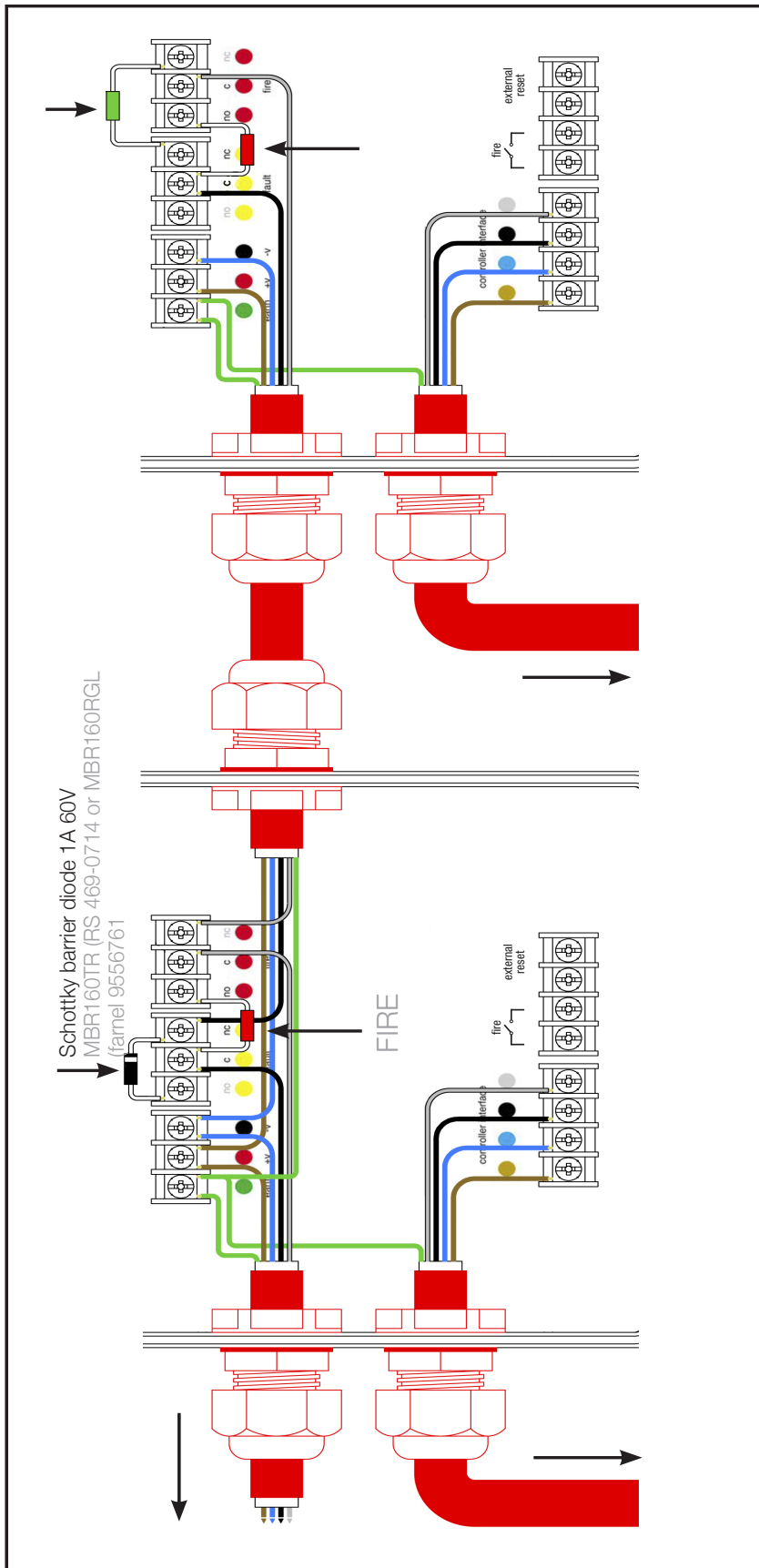

Multiple beams on a zone

## Other wiring diagrams

See our support website for further diagrams including interfacing with manufacturers protocols  
[www.contextplus.co.uk](http://www.contextplus.co.uk)

# step 3 commissioning

Commissioning **thebeamray** is a simple procedure outlined in the following step by step explanation.

**Ensure the installation guidelines have been followed correctly and that thebeamray has a clear line of sight through to the reflector and there are no obstacles in its path.**

## stage one, language and commissioning speed

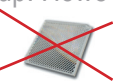
- Important.** Do **NOT** put the reflector up. However, if you are recommissioning **thebeamray** **COVER** it with a non-reflective black cloth or similar.  **You cannot commission the beam if the reflector can be seen**

- Power up the unit and you will see 

|            |
|------------|
| thebeamray |
| RFX70      |

 the screen will default to Fault or Fire 

|             |       |
|-------------|-------|
| Air Quality | 0%    |
| Status      | Fault |

- Access the menu by pressing **enter** 

- The first screen you see is 

|         |
|---------|
| english |
|---------|

 if you need to change this use the **right** and **left** hand keys to scroll through languages, when you have found your language press **enter** to access the commissioning menu. *If you have changed the language the system will continue in your chosen language.*

- Press **enter** and you will now see the **commissioning speed** screen. In most cases it is recommended to use **fast** mode (in normal mode the system uses 3.5mA, in fast mode it uses 17mA) - if you are commissioning more than one beam at a time and the system cannot support the extra draw it may be necessary to use normal mode to prevent excessive current draw. Fast mode allows x4 times faster motor response and it may be quicker to commission each beam in turn. Once commissioning is complete **thebeamray** will automatically revert to normal low power mode - (3.5mA).

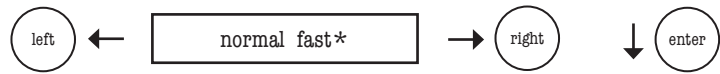

- Use the **left** and **right** keys to toggle between fast and normal, the **\*** indicates which mode is selected. Press the **enter** key to continue.

## stage two, pre-alignment

- The next screen is 

|               |
|---------------|
| pre-alignment |
|---------------|

**this is the most important part of setting up your beam.** Pre-alignment sets up the amount of power you need for the distance you are covering and can indicate if you are receiving unwanted reflections from anything else in the beam path.

- Press **enter** to begin **pre-alignment**. Remember **no reflector**. You will see the screen below. Take a moment to understand what the figures on the screen mean.

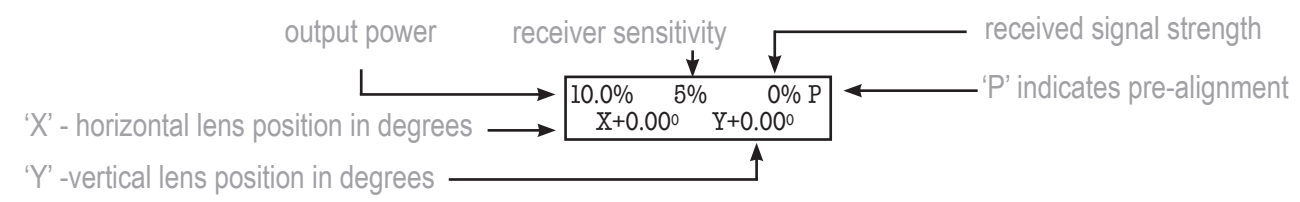

## Pre Alignment continued

Receiver sensitivity (RX Sense) will start by raising to 100% and then the output power (IR power) will rise to 100%. More power will be output than is necessary to cover the distance and these levels will then be reduced once the auto align process takes place. The air quality figure at this point should normally stay at 0%.

Pre-Align Complete will now be indicated

9. Press enter to accept Pre-Alignment and confirm these settings by pressing the right key and enter into Manual Alignment.



the beamray is looking for the far wall of the building and in some shorter distance applications will stop raising the IR Power when its sufficient for the distance. In these cases you can press Enter to accept the Pre-Alignment then right key and enter into Manual Alignment.



**CAUTION:** If you have not allowed the 50cm radius and the beamray encounters an obstruction this will also stop raising the IR Power and halt the Pre Alignment as the beam will assume it has found the far wall. You will need to identify and move the obstruction or reconsider the positioning of the beamray. You can identify that the beam is obstructed by the right hand figure (Air Quality) has risen and may fluctuate between 5%-10%.

Obstructions near the head will disturb the pre-alignment process and care should be taken to ensure no solid objects are close to the beam path.

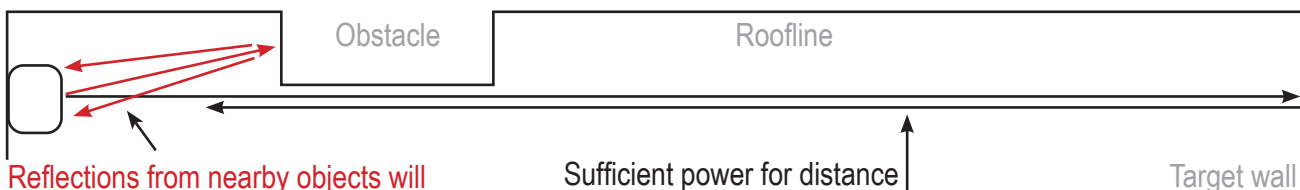

Reflections from nearby objects will limit the output power and prevent ability of the beam to cover the required distance

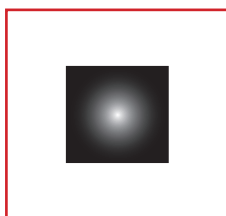

Ensure 1m of clear space along the path of the beam and 500mm from the edges of the reflector. if the wall you are placing the reflector/s on is shiny or glass then the reflectors should be placed on a 1meter piece of non-reflective material like MDF to ensure correct operation.

To find more information on Pre-Alignment look at our FAQ's which can be found on [www.contextplus.co.uk](http://www.contextplus.co.uk)



### stage three, manual alignment

Once Pre Alignment is complete you will enter Manual Alignment.

#### 10. NOW place or uncover the reflector

When you install or uncover the reflector the Right hand Figure (AQ) will jump up as high as 135%, this clearly shows that the beamray can see the reflector and you can press Enter to move to Auto Alignment.

|         |         |      |   |
|---------|---------|------|---|
| Manual  | AQ      | 125% | ✓ |
| X+0.00° | Y+0.00° |      |   |

As long as there is a received signal of at least 80 to 100% ideally over 100% you can move onto the next stage: **Auto Alignment No.11.**

If the beamray AQ does not rise significantly you will need to use the Left Right Up Down keys to move the Eyes of the beamray onto the reflector and once you have targeted the beamray onto the reflector the AQ will rise significantly.

|         |         |     |   |
|---------|---------|-----|---|
| Manual  | AQ      | 13% | ✗ |
| X+0.00° | Y+0.00° |     |   |

In the example below we can see that the reflector is below the eye line of the beamray head, so in this case you would need to lower the angle of the beam (-Y) until you receive an AQ of over 100%.

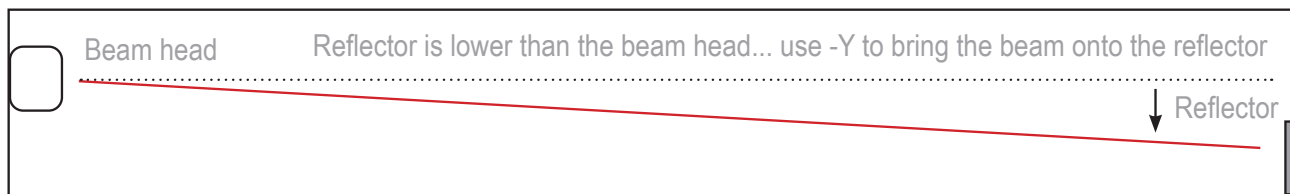

the beamray can be moved on both X and Y axis to a maximum 5 degrees using the left (x-), right (x+), up (y+) and down (y-) keys. Looking at the reflector this will move the beam across the reflector. Holding the keys down will quickly scroll through to your desired position, on release of the button the screen will revert to the actual beam position and can be seen stepping toward the requested position.

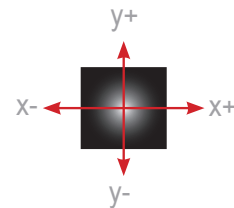

To confirm the beam is seeing the reflector covering the reflector at any time should drop the AQ and prove the beam is on the reflector.

In the example above moving the y axis down (y-) results in a greater AQ

|         |         |    |   |      |         |         |      |   |
|---------|---------|----|---|------|---------|---------|------|---|
| Manual  | AQ      | 6% | ↓ | down | Manual  | AQ      | 110% | ✓ |
| X+0.00° | Y+0.00° |    |   |      | X+0.00° | Y-1.26° |      |   |

Try and achieve as high an AQ as possible, it must be at least 80 to 100% ideally above 100%. Once you have achieved this you can move onto **Auto Alignment No.11.**

To find more information on Manual Alignment look at our FAQ's which can be found on [www.contextplus.co.uk](http://www.contextplus.co.uk)

## stage four, **auto-alignment**

11. Having received an AQ reading of over 100% in manual mode press **enter** to exit manual and **enter** again to go into **auto alignment** mode.



Auto Alignment is an automatic process that will firstly reduce the RX Sense and IR Power to accommodate the best settings for the **beamray** environment.

the **beamray** will automatically align to the centre of the Reflector, you will notice the X and Y axis moving as the **beamray** moves up, down, left and right to find the centre point.

When finished the **beamray** will state **Align Complete** and pressing Enter to confirm will show Air Quality 100% Status Normal.



The image shows a digital display with two lines of text: 'Air Quality 100%' on the top line and 'Status - NORMAL' on the bottom line.

**CAUTION:** This process should take up to 10 Minutes, if the **beamray** does not complete after this time then look at the X and Y axis to check it has not deviated off the reflector onto an obstruction. The X and Y figures should be below 1.50 on each axis and would normally be below 0.90.

If this is not the case you may need to start the Manual Alignment process again to return both the **beamray** axis to 0.00 and identify and remove the obstruction.

To find more information on Pre-Alignment look at our FAQ's which can be found on [www.contextplus.co.uk](http://www.contextplus.co.uk)

## step 4 testing

the **beamray** should now be tested for Fire and Fault.

the **beamray** **must be tested at the reflector end and not at the beamray head. This is to confirm it is looking at the reflector and completes the commissioning process.**

**FAULT** - Cover the reflector within 1 second with a non reflective card to simulate a fault such as a fork truck breaking the path of the **beamray**. After 10 Seconds the **beamray** should register FAULT and the Amber light will flash.

**FIRE** - Cover the reflector slowly up to 70% with a non reflective card to simulate a fire such as smoke entering the path of the **beamray**. After 10 Seconds the **beamray** should register FIRE and the Red light will flash.

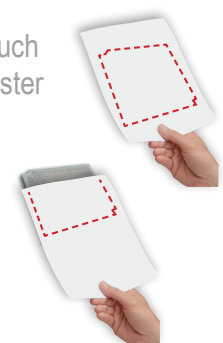

To find more information on Testing look at our FAQ's which can be found on [www.contextplus.co.uk](http://www.contextplus.co.uk)

**Once you have successfully completed both tests your the **beamray** is commissioned.**

You can now fine tune your beam to suit the environment if needed. Look through the following menus to see adjustments that can be made.

### 3 Screen and menu systems

#### Home screen

Air Quality 100%  
Status - NORMAL

This is the screen you would normally see when the beam is commissioned.

Other screens you may see are:

**FIRE**

Air Quality 29%  
Status - FIRE

The air quality level has fallen below the fire threshold setting.

If alarm is set to latching and you need to reset from fire press **enter**  to see this screen:

Alarm Reset

and press **enter**  again to reset and return to the normal screen.

This can also be reset by dropping the power to the beam for 5 seconds. If set to auto reset it will reset to normal automatically. See the menu system on page 13 to change between auto and latching if required

**FAULT**

Air Quality 0%  
Status - FAULT

The beam path has been fully blocked within 1 second (used when fault testing in commissioning).

**ERROR**

Air Quality XX  
Status - ERROR

No communication with the controller. This could be that the flying lead is not connected, or that the head is not connected to the controller, this can be checked by reading the resistance across the black and grey terminals, if connected it should read 110ohms if not connected at one end this will read 220ohms.

**ALIGN**

Air Quality 89%  
Status - ALIGN

This screen will appear when the beam is performing a self alignment, normally because of building movement.

**DIRT  
COMP**

Status - Dirt Comp



This is due to the compensation for dirt build up reaching its maximum - **FAULT** or **FIRE LED** may be flashing.

#### How to use the menu system

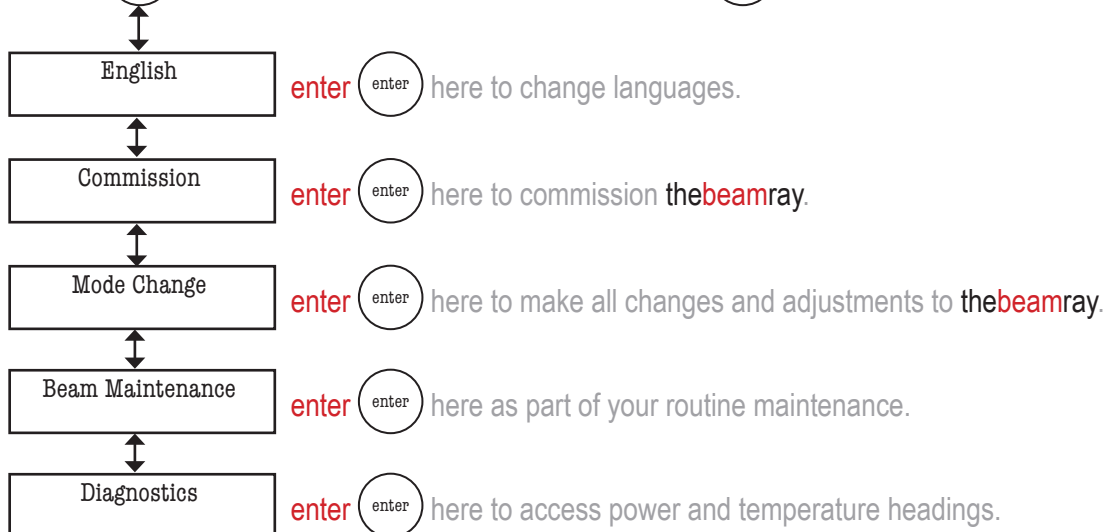
Press **enter**  to go into the menu system, then press **down**  to go through the main menu options:

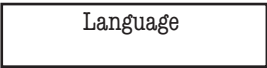

## Individual menu items

1.  The **language** is factory set to English if this is okay press **enter**  to continue to commissioning or arrow **up** to return to the home screen. To change the language use the **right** and **left** keys to change to your preferred language and press **enter** to confirm your choice – you will then continue in the language of your choice. Languages currently available are: English, Dutch, Italian, French, Spanish, Czechoslovakian and German.

2.  Press **enter**  to go into **commissioning**.

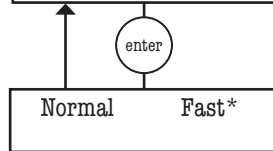

Pressing **right** or **left** changes between normal and fast. It is recommended in most cases to use **fast** mode (in normal mode the system uses 3.5mA, in fast mode it uses 17mA) - if you are commissioning more than one beam at a time and the system cannot support the extra draw it may be necessary to use normal mode to prevent excessive current draw. Fast mode allows x4 times faster motor response and it may be quicker to commission each beam in turn. Once commissioning is complete **the beamray** will automatically revert to normal low power mode - (3.5mA).

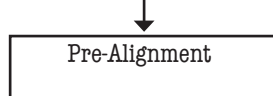

Press **enter**  to start pre-alignment. In pre-alignment you should **ALWAYS COVER THE REFLECTOR**. Starting at 10% power and 5% receiver sensitivity, the receiver sensitivity will automatically increase to a maximum of 100% then the output power will increase. These settings will automatically stop when a received signal strength reaches 6% - this received signal is the returned strength of the output signal without a reflector (if no return signal is received the beam will reach full power and the screen will say **Pre-Align - complete**). If you don't receive high enough output power and receiver sensitivity readings this will usually be because you are receiving a reflection from an object nearby - use the **left, right, up** and **down** keys to avoid the obstruction. When happy with your readings press **enter** and confirm by pressing the **right** button, this will take you to manual alignment - if you wish to abort **Pre-Align** press the **left** button.

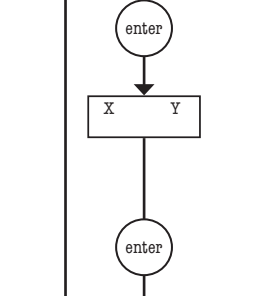

Press **enter**  to go into manual alignment - **NOW THE REFLECTOR CAN BE PLACED OR THE COVER CAN BE REMOVED**. You should see a large jump in signal strength. If no jump is seen use the **X** and **Y** keys to locate the reflector (the better the signal strength the better the beam is aligned) try to achieve a figure of around 100% or over for optimum **auto alignment** times. Press **enter** to okay this and go to **auto alignment**.

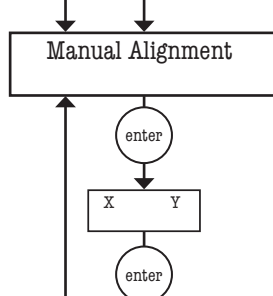

Press **enter**  to start auto-alignment. The beam will calibrate its power and search for the edges of the reflector – adjusting its power as it aligns itself onto the reflector. Once it has found all four edges twice it will then centre itself on the middle of the reflector and the screen will say **align complete**. Press **enter** to return to the **home screen**. If you see **align aborted** this means something has crossed the beam path of the received signal and the signal has dropped out. Press **back / left** to return to **auto alignment**.

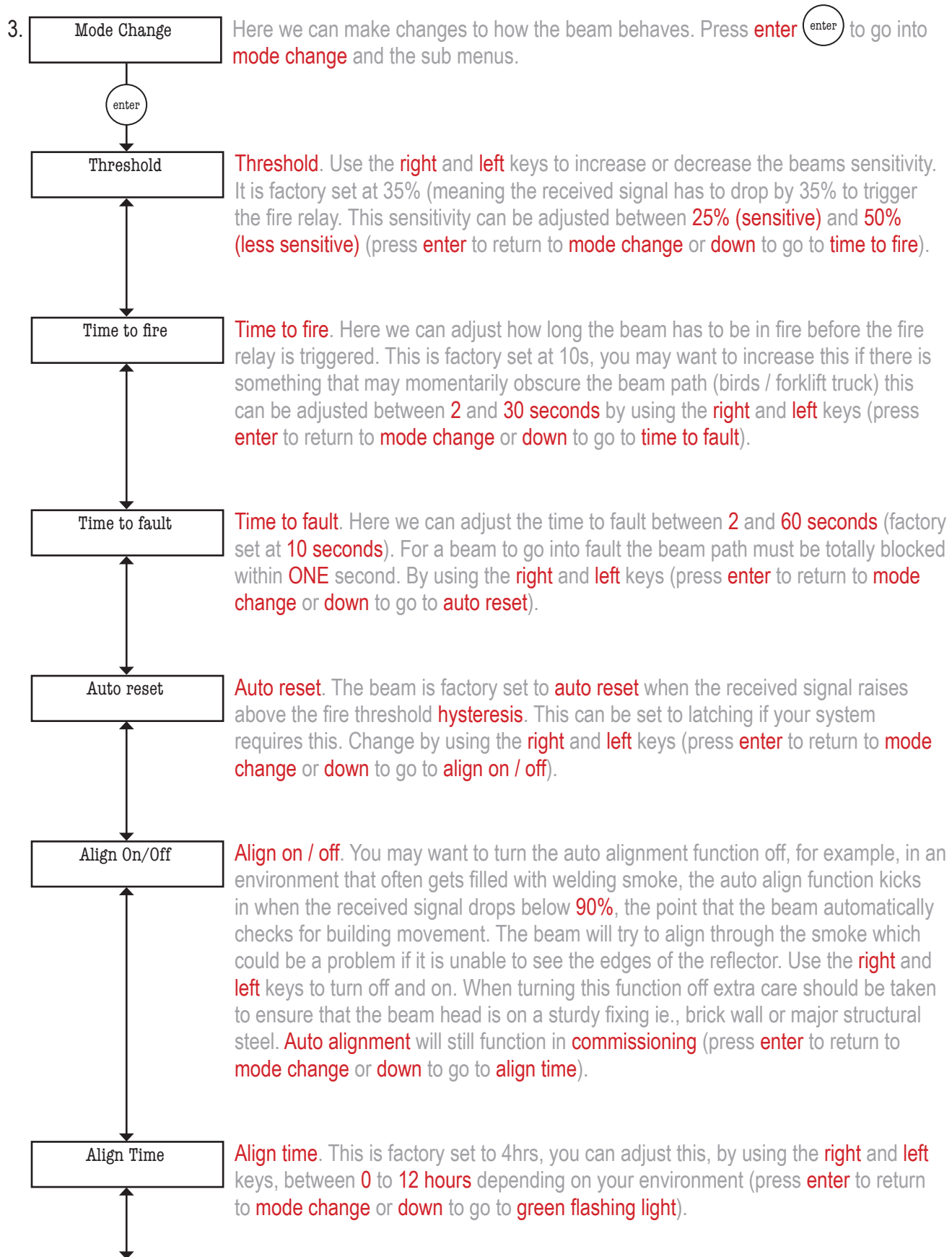

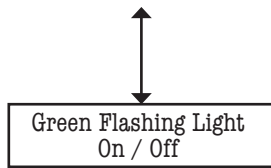

**Green flashing light on / off.** By using the **right** and **left** keys you can turn the green flashing LED, located on the head and controller, **on** or **off**. This is a useful way of identifying the beam head you are working with (press **enter** to return to **mode change** or **down** to go to **phase**).

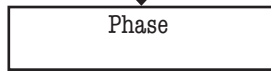

**Phase.** When using multiple beams that face each other the beam output signals could phase together and can cause unreliable readings, by setting each beam to phase differently alleviates this problem. Use the **right** and **left** keys to give each beam a different phase pattern (length between output beam sample times) you can choose between **0** (default setting) and **6** (press **enter** to return to **mode change** or **down** to go to **hysteresis**).



**Hysteresis.** Changing the **hysteresis** will change the delay in returning from a **fire** state back to a **normal** state, for example, the beam is factory set at 15% so if the beam falls into fire at 65% (35% threshold) it has to recover 15% to 80% before it returns to normal. This action prevents small fluctuations in returned signal causing the beam to fall in and out of a fire state. This can be adjusted between **1%** and **40%** by using the **right** and **left** keys (press **enter** to return to **mode change** or **down** to go to **compensation fire / fault**).

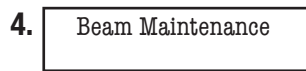

Press **enter** to go into **beam maintenance**.



**Dirt Comp.** This screen shows how much the beam has compensated for dust build-up on the beam head and reflectors, **ALWAYS** take a note of this value as part of your routine maintenance to see any build-up pattern, if you see figures above **+50%** you should clean both the lens face and the reflectors (once cleaned you should instigate an **auto alignment** to re-calibrate the beam settings).

It is possible that you may see a negative number here, this can happen when **the beamray** has been commissioned in a 'dirty' atmosphere such as builders dust which, once cleared, the beam then compensates for. To reset, perform an **auto alignment** to re-calibrate the beam (press **enter** to return to **beam maintenance** or **down** to go to **event counts**).

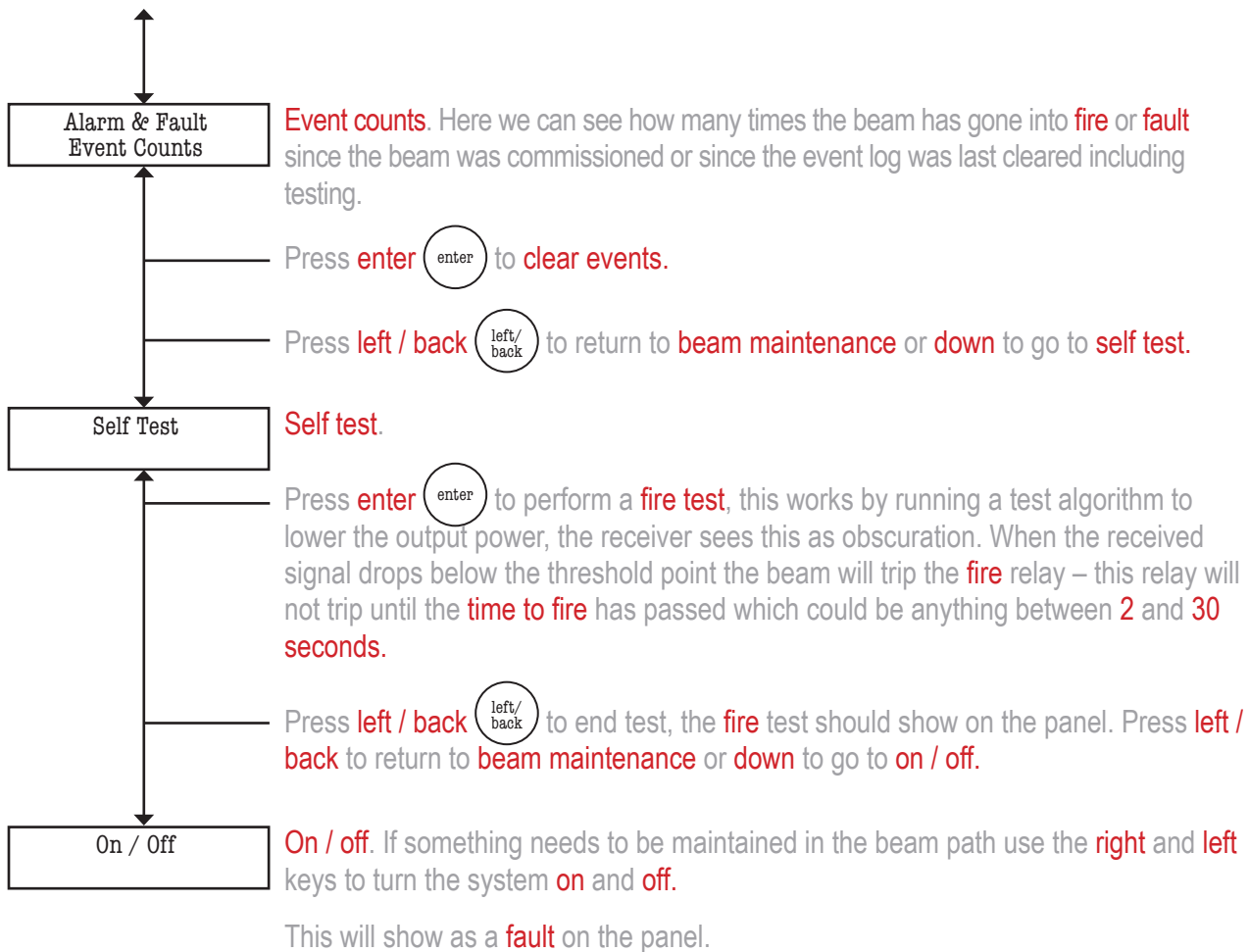

5. **Diagnostics** Press **enter** (enter) to go into **diagnostics**.

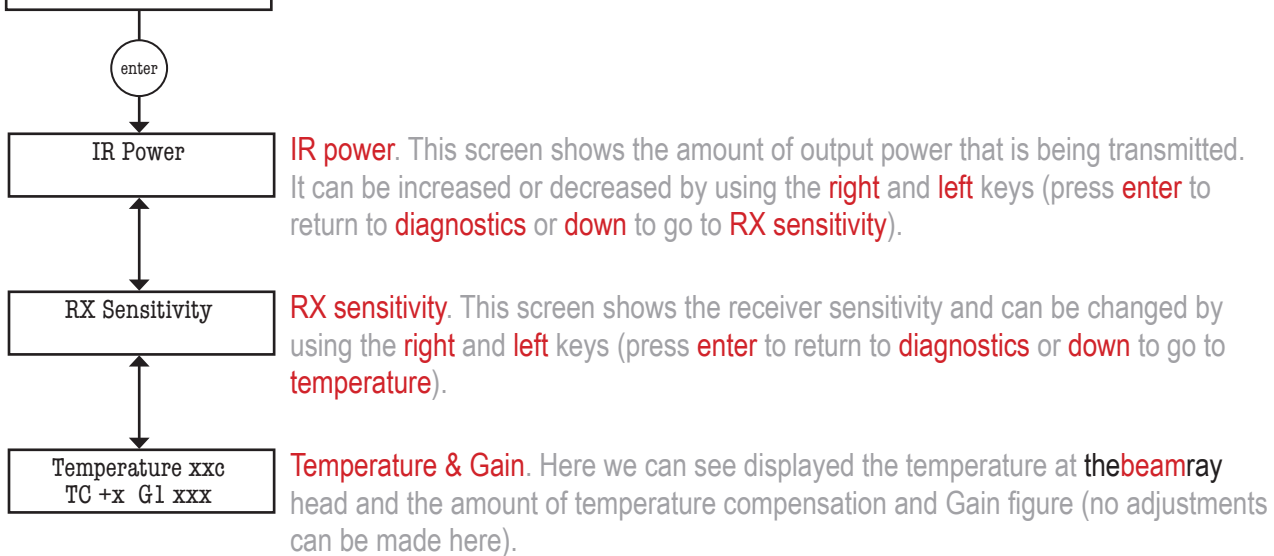

Press **enter** (enter) to return to **diagnostics**.

**FAQ's.** a comprehensive list of FAQ's can be found on [www.contextplus.co.uk](http://www.contextplus.co.uk)

# technical specifications

## Electrical Specifications:

**Supply Voltage.** 12 to 30 Vdc normal

**Supply Current.** 3.5mA (constant current)  
in all operational states

**Constant Current.** 17mA (constant current)  
in fast commissioning

## Environmental Specifications:

**Temperature.** -10°C to +55°C

**Humidity.** 10 to 95% RH Non-condensing

**Protection Index.** IP65 when suitably  
mounted and terminated

## Mechanical Specifications:

### Beam Head.

180mmH x 155mmW x 137mmD  
Weight 1.1Kg

### Controller.

185mmH x 120mmW x 62mmD  
Weight 0.55g

### 70KIT140 Mid-Range Reflector.

293mmH x 293mmW x 5mmD  
Weight 0.8Kg

### 140KIT160 Long Range Reflector.

394mmH x 394mmW x 5mmD  
Weight 1.8Kg

### Adapter.

270mmH x 250mmW x 5mmD  
Weight 0.6g  
(mounts the Beam Head onto unistrut)

## Optical Specifications:

**Optical Wavelength.** 870nm

**Maximum Angular Alignment.**  $\pm 5^\circ$

**Maximum Angular Misalignment.**

(static not auto-aligning)

Beam Head  $\pm 0.4^\circ$  Reflector  $\pm 2^\circ$

## Operational Specifications:

**Protection Range:**

### BEAMRAY RFX70

Standard Product 7 to 70 metres. Use short range mask  
for distances between 7 & 20 metres

### 70KIT140.

Mid-Range Reflector Kit 70 to 140 metres

### 140KIT160.

Long Range Reflector Kit 140 to 160 metres

**Alarm Sensitivity Levels:**

25%(1.25dB) to 50%(3dB) in 1%(0.05dB)  
increments (default 35% (1.87dB))

**Alarm Condition:**

Obscuration drops to below pre-defined  
sensitivity level.

Time to Alarm Condition adjustable

2 to 30 seconds in 1 second increments  
(default 10 seconds)

**Alarm Indication:**

Controller Status – FIRE

Controller Red Flashing LED

Head Red Flashing LED

Alarm Relay Change Over (CO) Contact

Rating 2A @ 30 Vdc

**Test/Reset Features:**

Beam test function by controller

Alarm latching/auto-reset selectable  
(default auto-reset)

Alarm reset in latching mode by controller reset  
function, removing power for >5 seconds or  
momentarily apply >5 VDC to reset connections in  
Beam Head.

**Fault Sensitivity Level:**

<4%

**Fault Condition:**

Obscuration drops to below the fault  
sensitivity level within 1 second  
Power Down or Supply Voltage < 9 VDC

Commissioning modes, Pre-Alignment  
and Auto Alignment

Beam turned off during Beam Maintenance Time to  
Fault Condition adjustable,  
2 to 60 seconds in 1 second increments  
(default 10 seconds)

**Fault Indication:**

Controller Status – FAULT

Controller Yellow Flashing LED 1 Second

Head Yellow Flashing LED 1 Second

Fault Relay Change Over (CO) Contact

Rating 2A @ 30 VDC

**Normal Condition:**

Obscuration level is above the  
Alarm sensitivity level

Controller Status – NORMAL

Controller Green Flashing LED

Programmable on/off

Head Green Flashing LED

Programmable on/off

**Auto-align/Beam Contamination**

**Compensation:**

Auto-align during normal operation if  
obscuration drops below 90% for the duration of the  
align time set  
(doesn't effect normal operating mode)

Beam Contamination Compensation 4 hour monitoring.  
Compensation data available at the controller